

Features:

- Direct solenoid actuated directional spool valve
- Wet pin DC solenoids with removable coil (AC voltages possible via a rectifier)
- Solenoid coil can be rotated through 90°
- The coil can be replaced without opening the pressure-tight chamber
- Individual electrical connections
- Hand override, optional
- Adjustable spool switching time, optional
- Porting pattern to Din 24 340 form A, ISO 4401 and CETOP-RP 121H

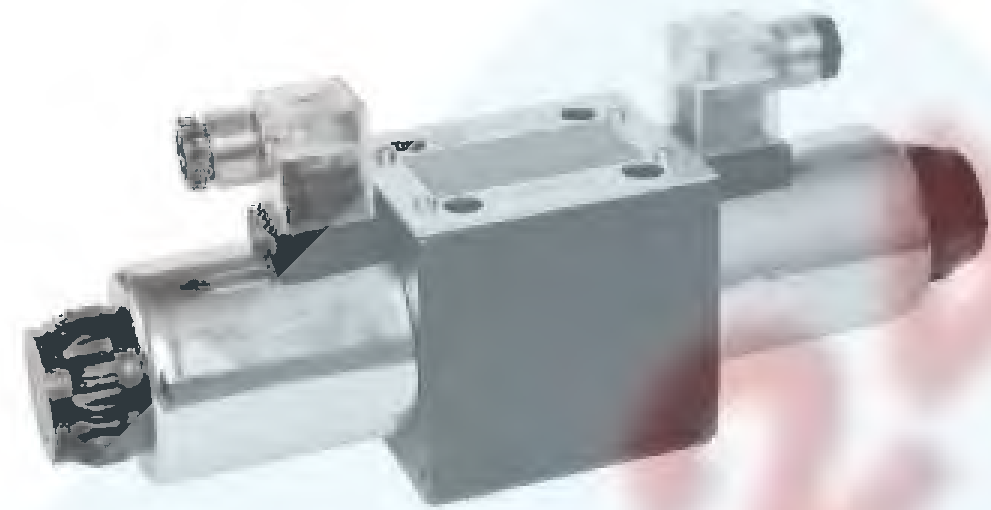

Function, section

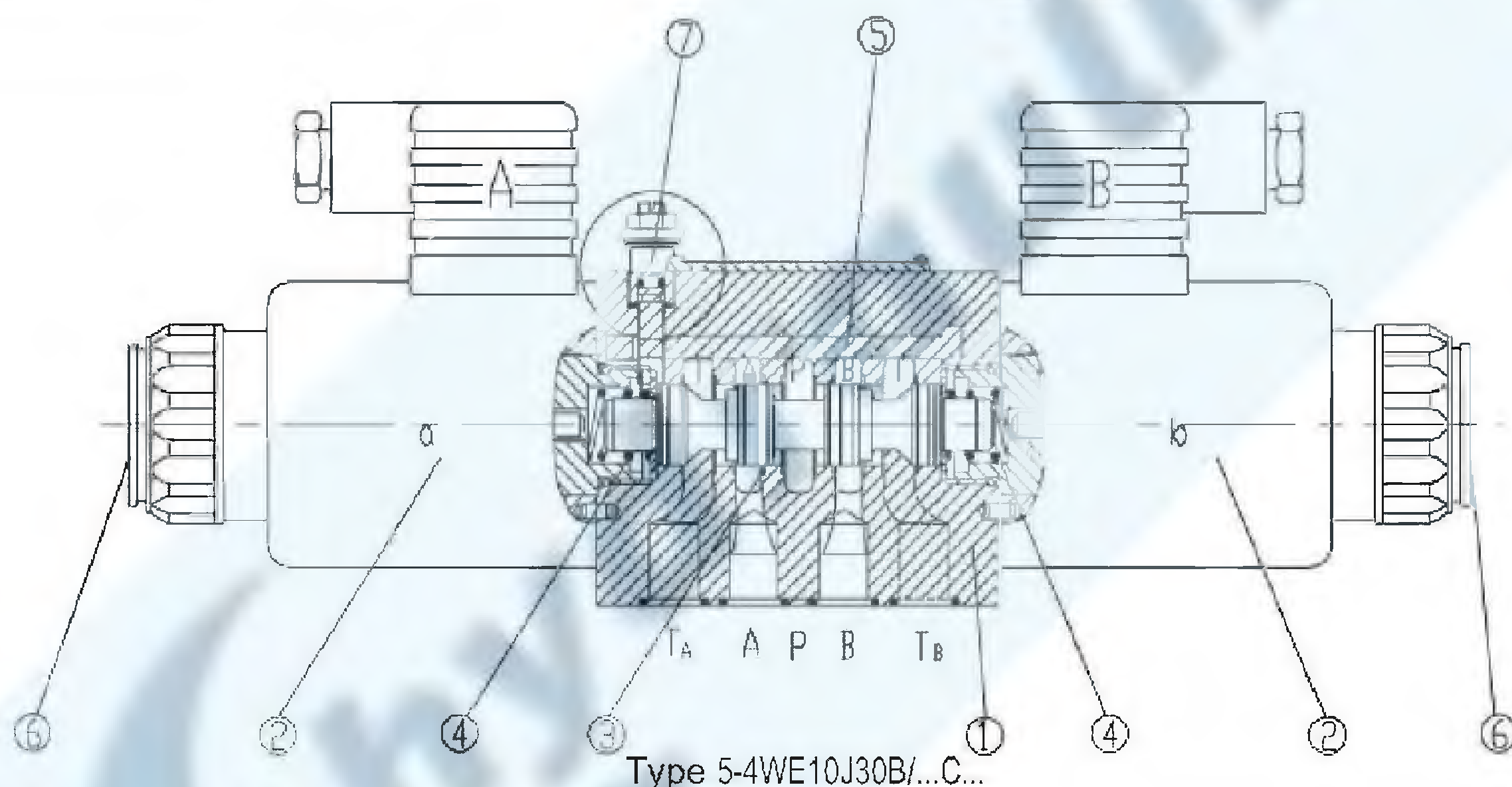

5-chamber directional valves of type 5-.WE are solenoid operated directional spool valves. They control the start, stop and direction of flow with the additional option of adjusting the spool switching time. These directional valves basically consist of the housing (1), one or two solenoids (2), the control spool (3), as well as one or two return springs (4). The two spring chamber are connected by a connecting bore (5). As the spool switches, the flow is displaced from one spring chamber to the other via this passage. If the area of this connecting bore is reduced by an orifice, the switching time changes accordingly. The T channels are isolated from the spring chambers. This means that switching pulses do not affect the control spool (3) and thus, soft switching of the spool can be achieved. In the de-energized condition, the control spool (3) is held in the central or initial position by return springs (4) (except for impulse spools). The control spool (3) is actuated by wet pin solenoids (2).

In order to ensure correct functioning, care must be taken to ensure that the pressure chamber of the solenoid is filled with oil.

The force of the solenoid (2) acts on the control spool (3) and switches it from its rest position to the required end position. This then permits flow from P to A and B to T or P to B and A to T. When the solenoid (2) is de-energized the control spool (3) is returned to its rest position by the return spring (4). A hand override (6), optional, enables the control spool (3) to be moved without energization of the solenoids.

Adjustable spool switching time (only with DC solenoids)
The optional installation of an orifice screw (7) or orifice (8) - see below - offers the possibility of increasing switching time

- with orifice screws type 5-.WE 10 ../..CG../C..
- with throttle type 5-.WE 10 ../..CG../A..

Funtion,secion

With the installation of orifices, the spool switching time may be lengthened by more than 100 ms. The actual time is dependent upon the individual system (e.g. pressure, flow and viscosity).

When re-to-fitting or modifying a throttling system, care must be taken that the fluid volume in the spring chambers and the connecting bore (5) is retained, as this is a prerequisite for the smooth operation of the switching time adjustment.

Type 5-WE 10.30/OC....

(only possible with symbols A, C and D)

This version is a directional valve with 2 switched positions and 2 solenoids without detent. There is no defined spool position in the de-energized condition.

Type 5-WE 10.30/OFC... (impulse spool), with detent

(only possible with symbols A, C and D)

This version is a directional valve with 2 detented switched positions and 2 solenoids. Thus, the spool is held in the last switched position, permanent energisation of the solenoid is not required.

Throttle insert (type 5-WE 10.30/.../B..)

The use of a throttle insert is required if, due to the operating conditions, flows can occur during the switching process which are larger than the performance limits of the valve allow.

The orifice is to be inserted into the P channel of the directional valve.

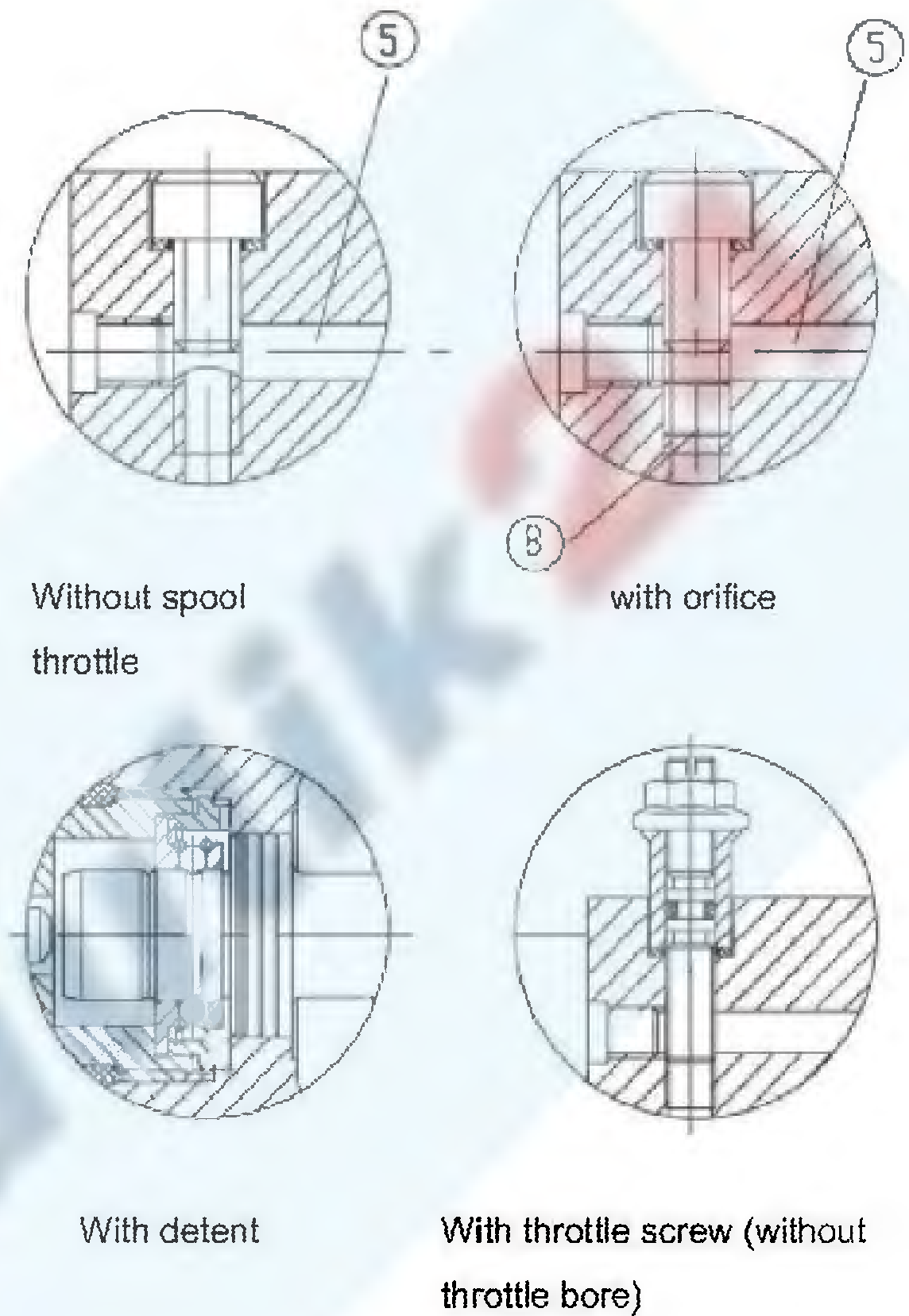

Symbols

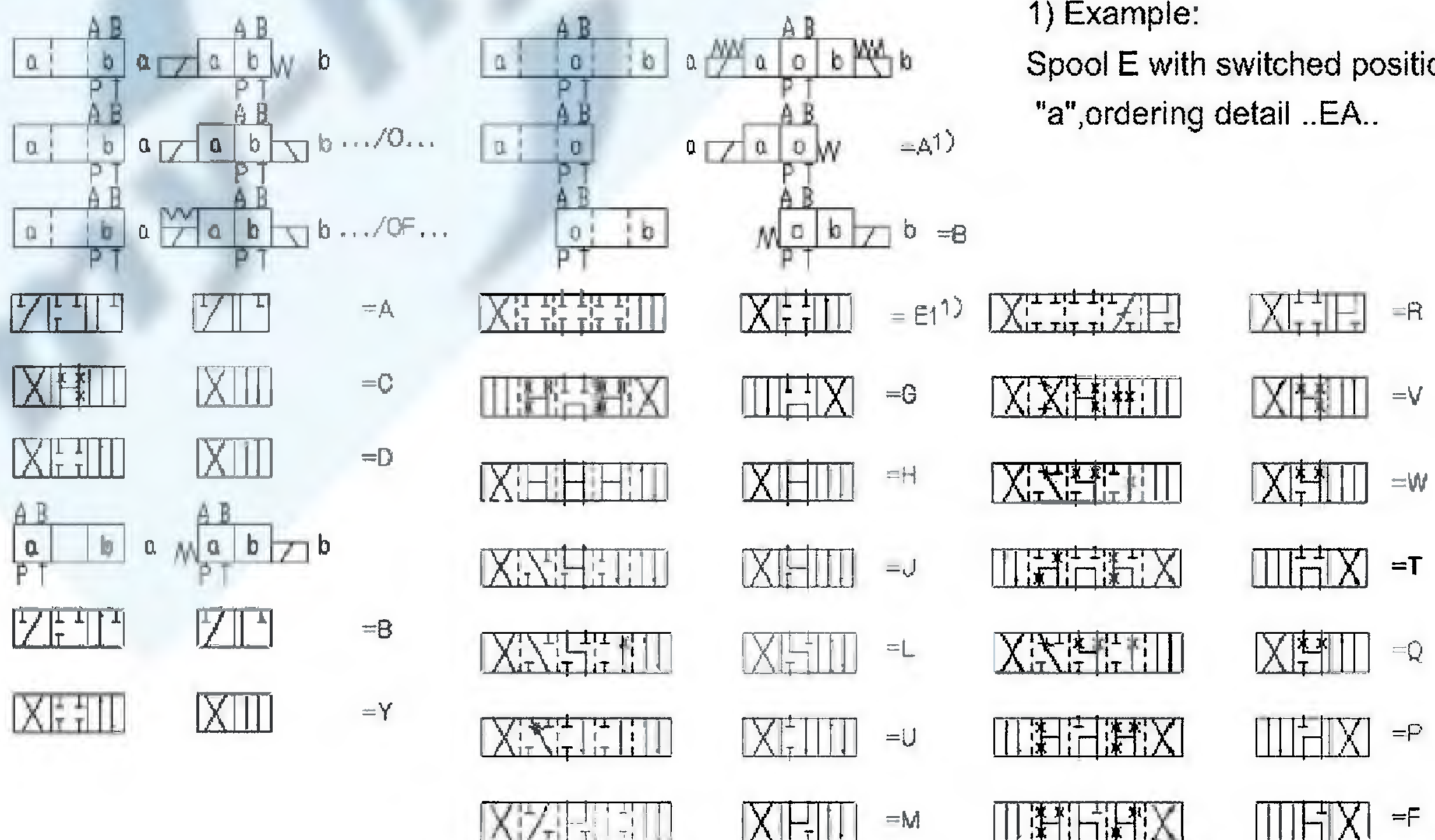

Ordering details

5-	WE	10		31	/							*
----	----	----	--	----	---	--	--	--	--	--	--	---

3 service ports = 3
4 service ports = 4

Nominal size 10 = 10

Symbol e.g. C, E, EA, EB etc.
- for possible versions, see sheet below

Series 30 to 39 = 31
(30 to 39: unchanged installation and connection dimensions)

With spring return = No code
Without spring return with detent = OF
Without spring return = O

Wet pin solenoid (oil immersed) with removable coil = C

24VDC = G24
220VAC, 50Hz or 240VAC, 60Hz = W220
DC solenoid commuting automatically = W220R

With protected manual override (standard) = N9
Without hand override = No code
Hand override with protective cap = N

Further details
in clear text

No code = mineral oils
V = phosphate ester

No code = Without cartridge
throttle

B08 = Throttle Φ 0.8 mm

B10 = Throttle Φ 1.0 mm

B12 = Throttle Φ 1.2 mm

B15 = Throttle Φ 1.5 mm

B30 = Throttle Φ 3.0 mm

No code = Without switching time
adjustment

C = With throttle screw

A06 = Orifice Φ 0.6 mm

A07 = Orifice Φ 0.7 mm

A08 = Orifice Φ 0.8 mm

A10 = Orifice Φ 1.0 mm

Single connection

Z = Plug-in connector on side

ZL = Plug-in connector on side, with light(s)

Central connection

D = Cable fed into cover

DL = Cable fed into cover, with light(s)

DZ = Plug-in connector on cover

DZL = Plug-in connector on cover,
with light(s)

Technical data (For applications outside these parameters, please consult us!)													
General													
Installation		optional											
Max. ambient temperature		(°C)	-30~+50										
Weight	Valve with 1 solenoid	(kg)	5.1(DC) ; 4.3(AC)										
	Valve with 2 solenoids	(kg)	6.7(DC) ; 5.1(AC)										
Hydraulic data													
Max. operating pressure	Ports A, B, P	(MPa)	31.5										
	Ports T	(MPa)	21 (DC) ; 16 (AC)										
Flow area		with symbols A and B, port T must be used as drain port, if the operating pressure is higher than the permissible tank pressure.											
Max. flow		(L/min)	120										
Pressure fluid		Mineral oil or phosphate ester											
Fluid temperature range		(°C)	- 30 to + 80										
Viscosity range		(mm ² /s)	2.8~500										
Degree of contamination		We, therefore, recommend a filter with a minimum retention rate of $\beta_{10} \geq 75$.											
Flow cross-section (switched position 0)	For symbol V	(mm ²)	11 of nominal cross section (A/B → T) ; 10.3 of nominal cross section (P → A/B)										
	For symbol W	(mm ²)	2.5 of nominal cross section (A/B → T)										
	For symbol Q	(mm ²)	5.5 of nominal cross section (A/B → T)										
Electrical data													
Type of voltage		DC	AC										
Available voltages (See below when ordering AC solenoids)		12, 24, 42, 60, 96, 110, 180, 205, 220	42, 110, 220, 230, 240 50/60Hz										
Power consumption (W)		35	-										
Holding power (VA)		-	90										
Switching power (VA)		-	550										
Duty continuous		Continuous	Continuous										
Switching time to ISO 6403	ON	(ms)	45 to 60										
	OFF	(ms)	20 to 30										
Switching frequency (cycles/h)		15000	7200										
Protection to DIN 40 050		IP65											
Insulation class VDE 0580		F	H										
Max. coil temperature (°C)		150	180										
1) special voltages on request		When connecting the electrics, the protective conductor (PE $\frac{1}{\text{I}}$) must be connected according to the relevant regulations.											
Note: These solenoids may be used for 2 types of supply: e.g. solenoid type W110 for: 110V, 50Hz 120V, 60Hz		<table border="1"> <tr> <td rowspan="2">Order Type</td> <td>W42</td> <td>42V, 50Hz 42V, 60Hz</td> </tr> <tr> <td>W110</td> <td>110V, 50Hz 120V, 60Hz 110V, 60Hz</td> </tr> </table>	Order Type	W42	42V, 50Hz 42V, 60Hz	W110	110V, 50Hz 120V, 60Hz 110V, 60Hz	<table border="1"> <tr> <td rowspan="2">Order Type</td> <td>W230</td> <td>230V, 50Hz 230V, 60Hz</td> </tr> <tr> <td>W220</td> <td>220V, 50Hz 220V, 60Hz</td> </tr> </table>	Order Type	W230	230V, 50Hz 230V, 60Hz	W220	220V, 50Hz 220V, 60Hz
Order Type	W42	42V, 50Hz 42V, 60Hz											
	W110	110V, 50Hz 120V, 60Hz 110V, 60Hz											
Order Type	W230	230V, 50Hz 230V, 60Hz											
	W220	220V, 50Hz 220V, 60Hz											

Characteristic curves (measured at $v = 41 \text{ mm}^2/\text{s}$ and $t = 50^\circ\text{C}$)

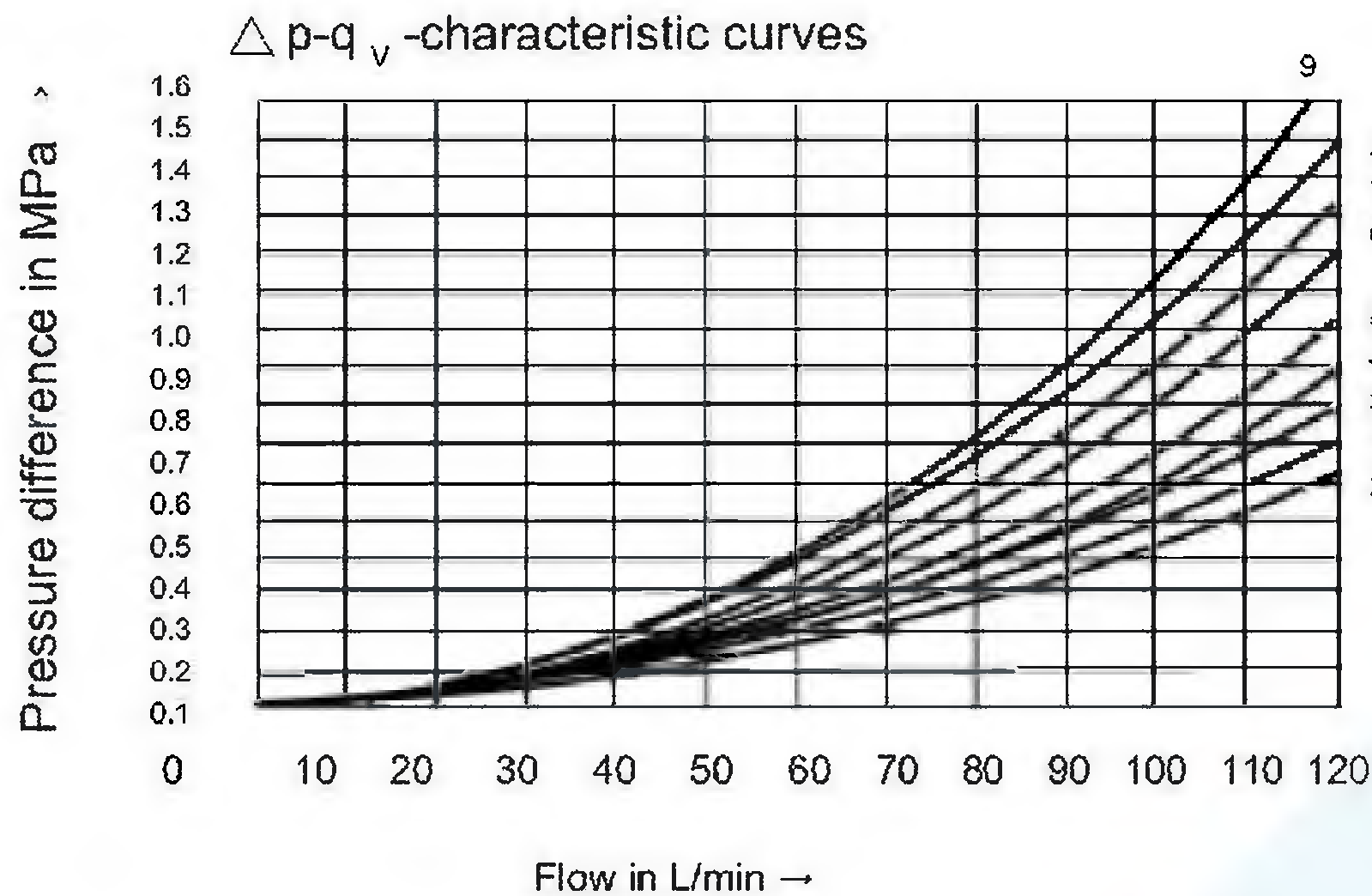

Symbols	Direction of flow			
	P-A	P-B	A-T	B-T
A,B	1	1	-	-
D,Y	2	2	1	3
E	2	2	3	4
F	2	1	4	7
G	4	4	6	8
H	2	2	1	3
J,L	1	1	4	4
M	2	2	3	4
P	2	1	1	7
Q,V	1	1	3	4
R	1	4	3	-
T	4	4	5	7
U	11	1	3	5
Centr. position		B-T	A-T	P-T
F		-	5	4
G		-	-	8
P		7	-	6
T		-	-	8
Choice. position		B-A		
R		9		-

Performance limits: (measured at $v = 41 \text{ mm}^2/\text{s}$ and $t = 50^\circ\text{C}$)

The performance limits shown are valid when the valve is used with two directions of flow (e.g. from P to A with simultaneous return flow from B to T). Due to the flow forces occurring within the valves, the permissible switching performance limits can be significantly lower with only one direction of

flow (e.g. from P to A and with port B blocked)! (For these applications, please consult us.)

The performance limits were determined with the solenoid at operating temperature, 10 % under voltage and with no preloading of the tank.

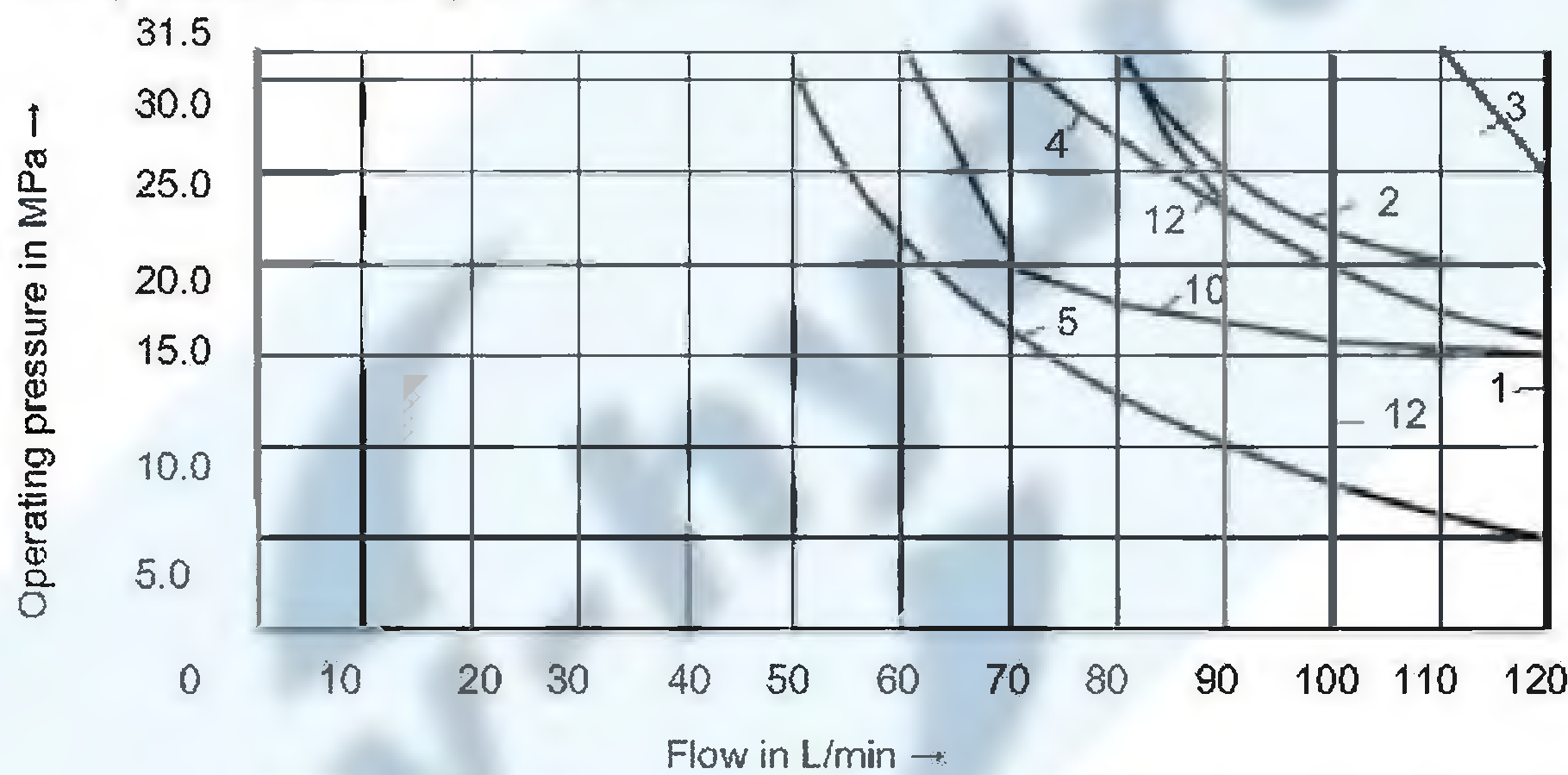

Char. curve	Symbols
With orifice $\phi 0.6 \text{ mm}$ ("A06")	
3	D,Y
12	C
With or without orifice	
1	C/O,C/OF
	D/O,D/OF,M
2	A/O,A/OF,E
	J,L,U,Q,W
4	G
5	F,P
10	H

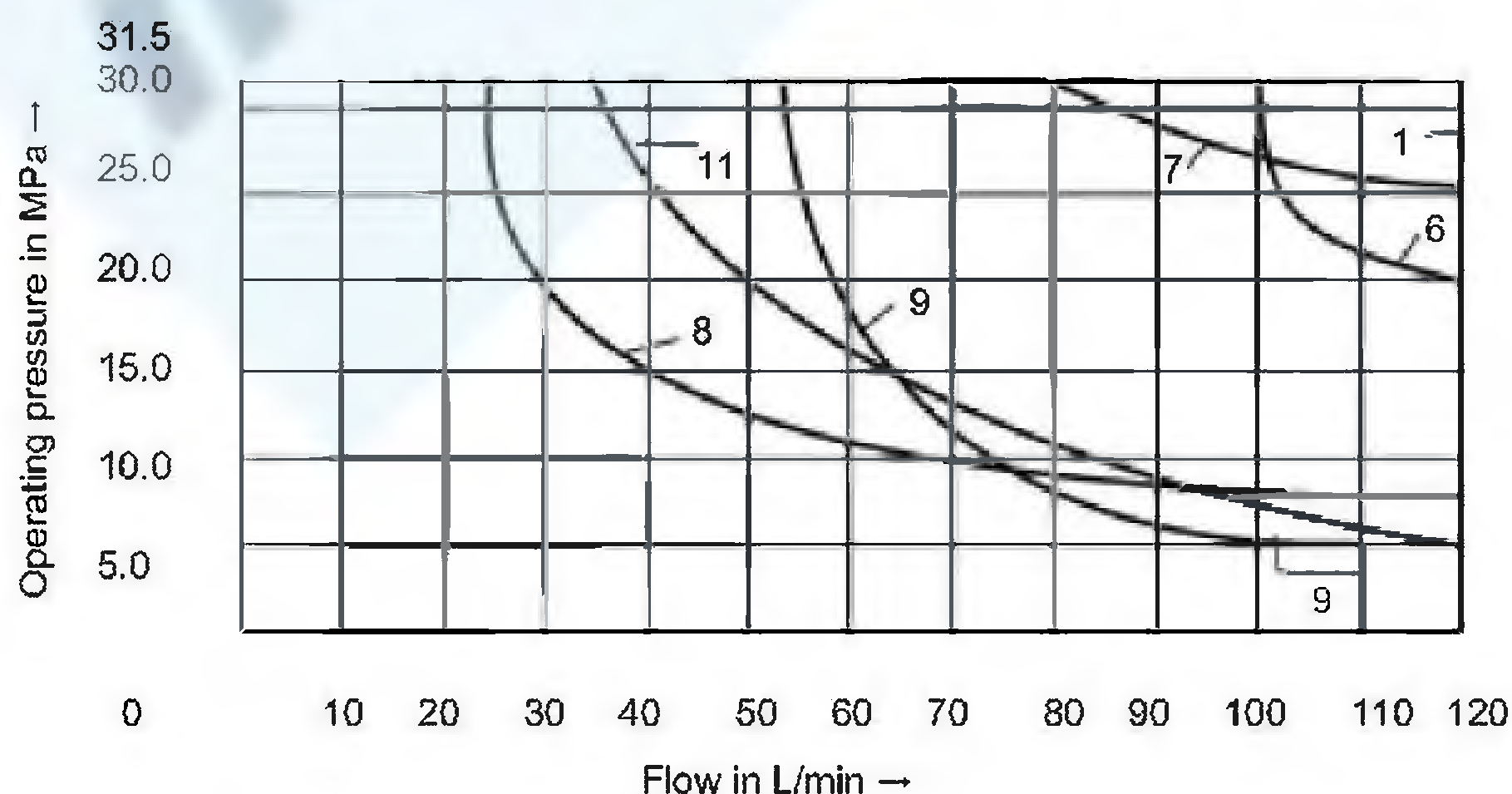

Char. curve	Symbols
Without orifice	
1	D,Y
6	C
7	R
8	T
9	V
11	A,B

Unit dimensions

(Dimensions in mm)

Individual connections

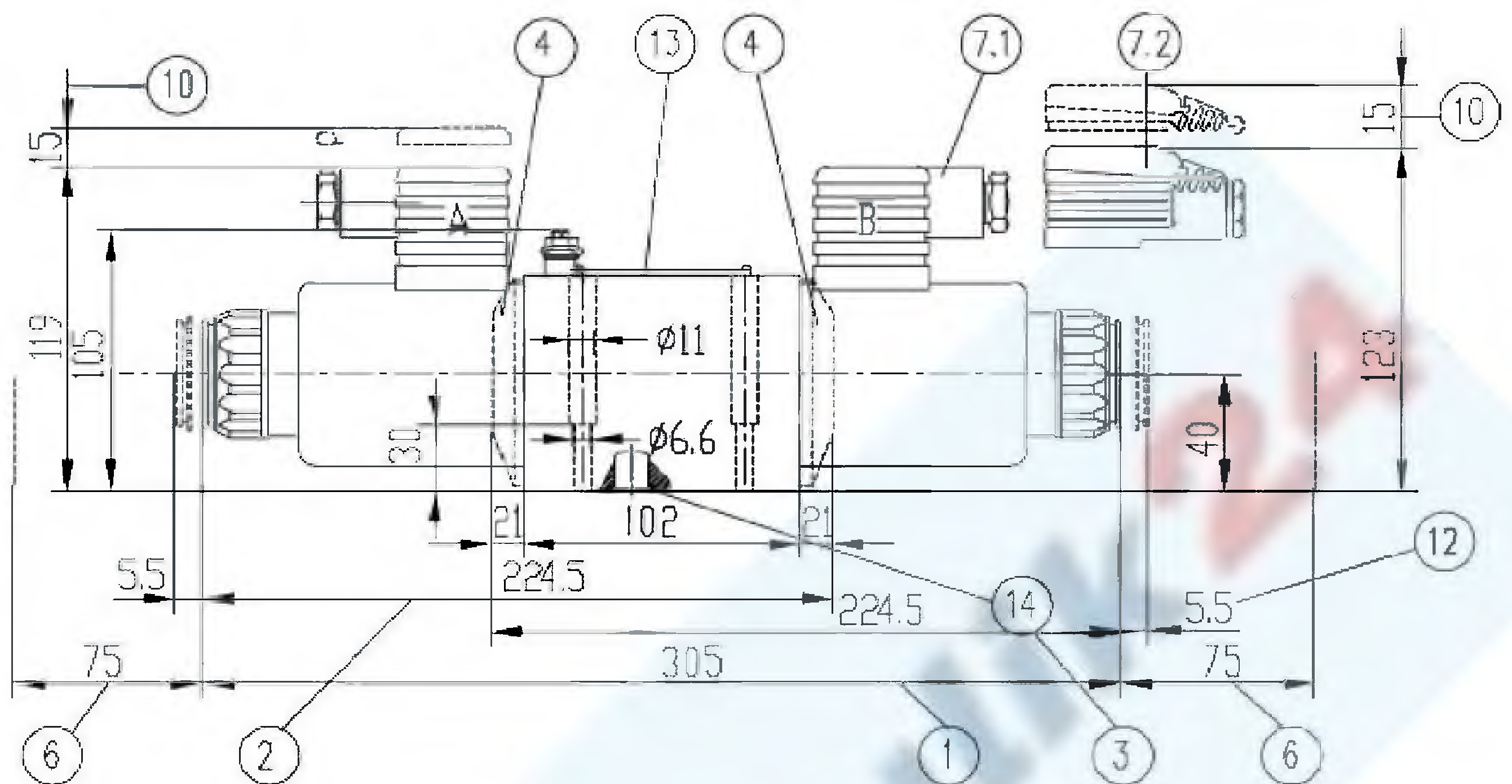

Central connection

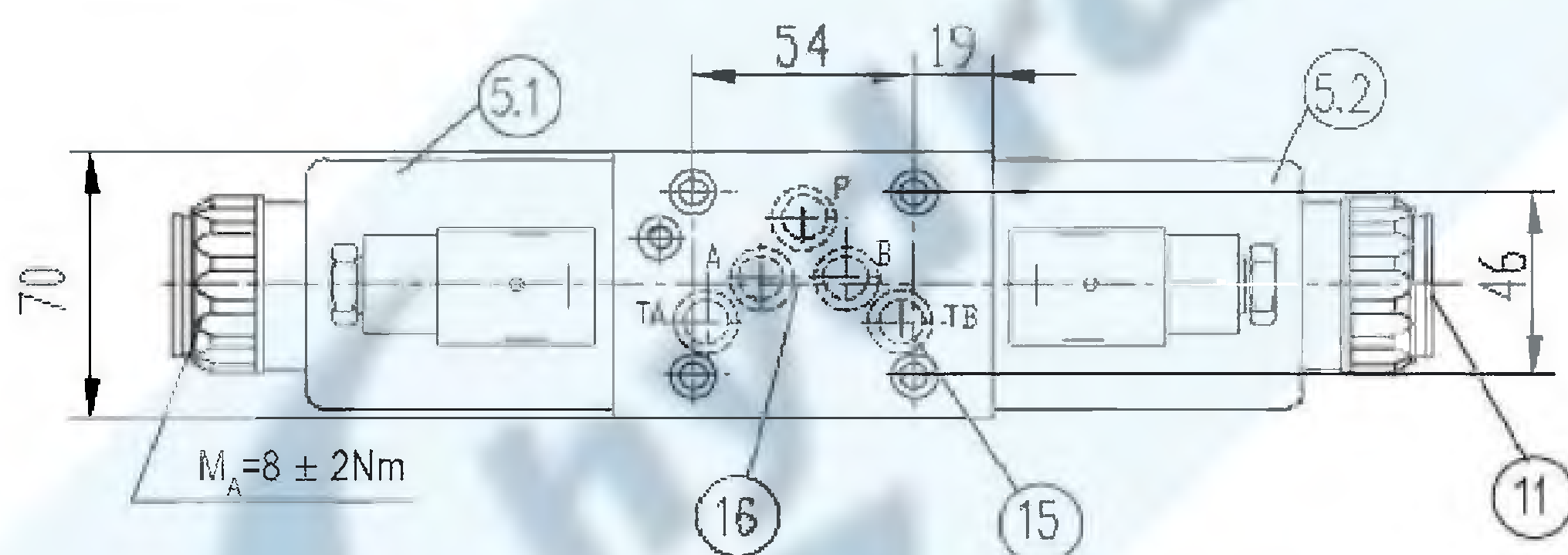

Required surface finish of mating piece

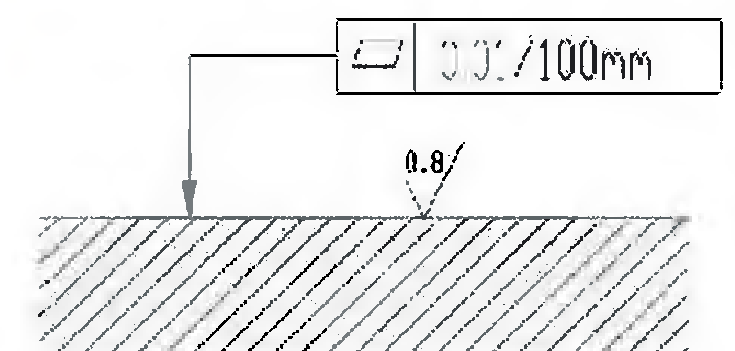

- 1 3-Position valve
- 2 2-Position valve
With 1solenoid (A, C, D, EA...)
- 3 2-Position valve
With 1solenoid (B, Y, EB...)
- 4 Plug for valve with 1 solenoid
- 5.1 Solenoid "a" (Plug-inconnector colour grey)
- 5.2 solenoid "b" (Plug-inconnector colour black)
- 6 Spece required to remove solenoid
- 7.1 Plug-in connector (may be rotated by 90°)
- 7.2 Plug-in connector of large code (may be rotated by 90°)
- 10 Spece required to remove plug in connection (A, C, D, EA...)

- 11 Hand override "N9"
 - 12 Dimension of hand override "N"
 - 13 Namplate
 - 14 O-rings 12X2
 - 15 Additional T port (TB) may optionally be used in conjunction with drilled blocks
 - 16 Porting pattern to Din 24340 form A ISO44101 and CETOP-RP121H
- Subplates:
 C66/01(G3/8)
 C67/01(G1/2)
 G534/04(G3/4)
 Valve fixing screws
 M6X40DIN912-10.9
 (GB/T70.1-2000)
 $M_A = 15.5Nm$
 must be ordered separately (see page 206)

- 
- ### Notice
1. The fluid must be filtered. Minimum filter fineness is 20 μm .
 2. The tank must be sealing up and an air filter must be installed on air entrance.
 3. Products without subplate when leaving factory, if need them, please ordering specially.
 4. Valve fixing screws must be high intensity level (class 10.9). Please select and use them according to the parameter listed in the sample book.
 5. Roughness of surface linked with the valve is required to $\frac{0.8}{\nabla}$.
 6. Surface finish of mating piece is required to 0.01/100mm.