

Features:

- Direct solenoid actuated directional spool valve high performance version
- Wet pin DC or AC solenoids with removable coil
- Solenoid coil can be rotated through 90 °
- It is not necessary to open the pressure tight chamber when changing the coil
- Electrical connections either as individual or central connections
- Hand override, optional
- Porting pattern to Din 24 340 form A, ISO 4401 and CETOP-RP 121H

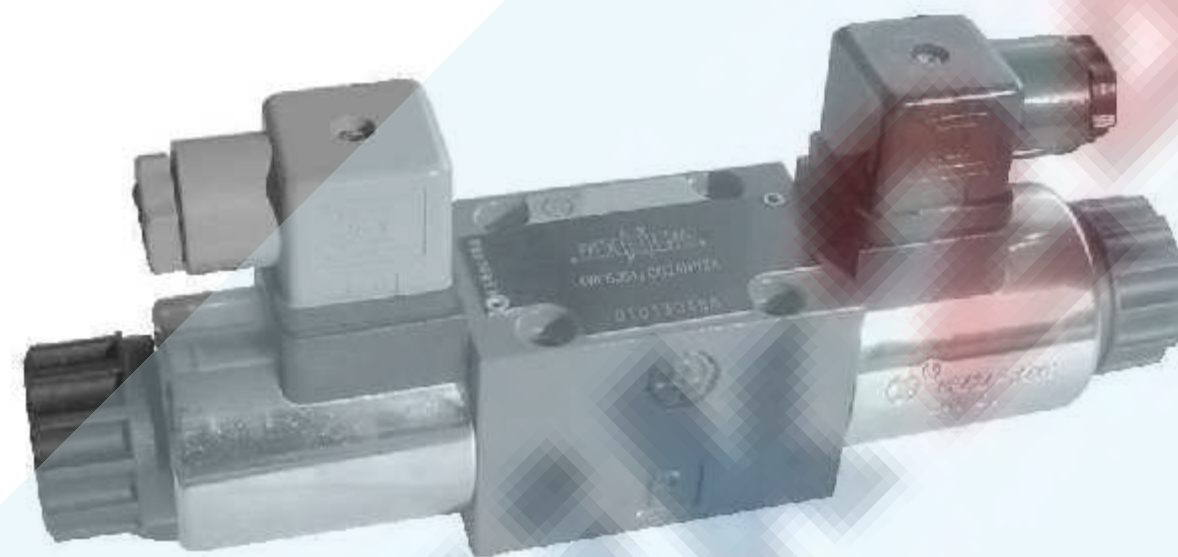

Function, section

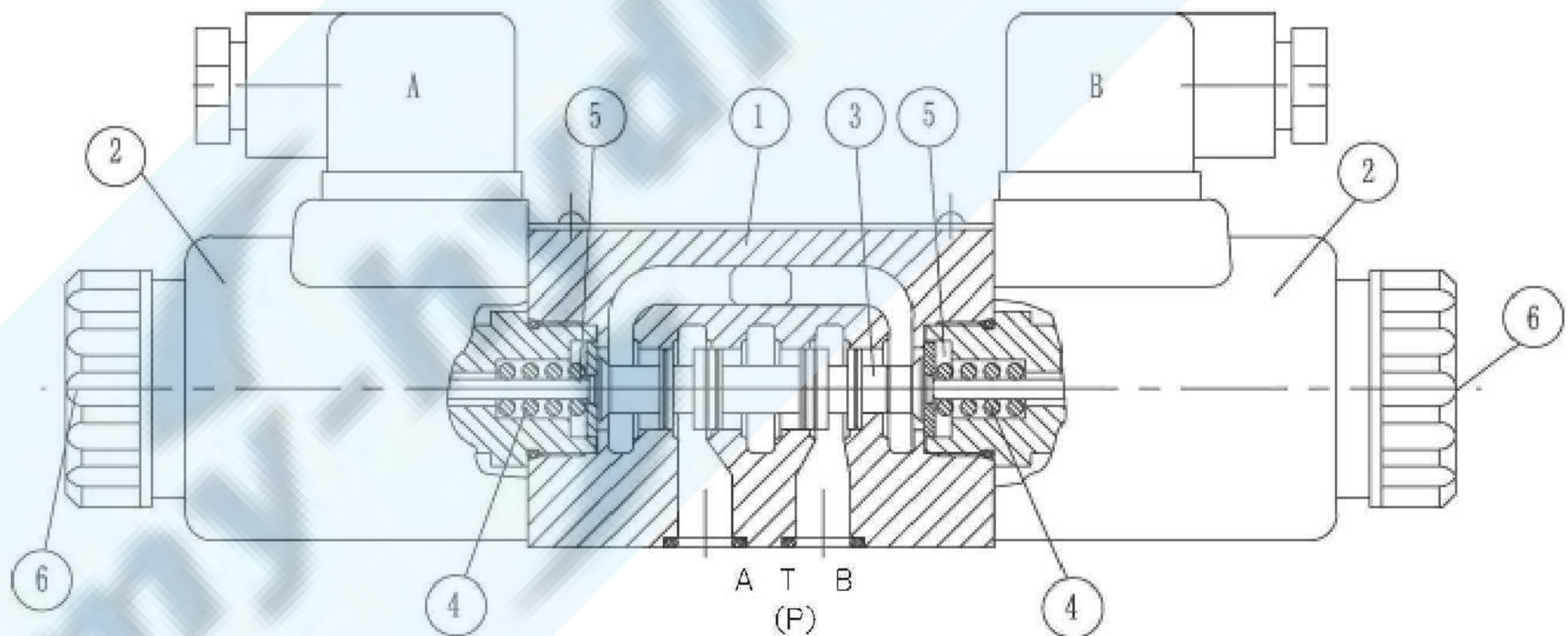

Type WE6...60B/

Essentially the directional control valves consist of housing (1), one or two solenoids (2), the control spool (3), and one or two return springs (4)

In the de-energized condition the control spool (3) is held in the neutral or initial position by means of return springs (4) (except for impulse spools). The control spool (3) is actuated via wet pin solenoids (2)

The force of the solenoids (2) acts via the plunger (5) on the control spool (3) and pushes this from its neutral position to the required end position. This gives free-flow

from P to A and B to T or P to B and A to T.

When solenoid (2) is de-energized, the control spool (3) is returned to its neutral position by means of the return springs (4).

An optional hand override (6), allows movement of the control spool (3) without energising the solenoid.

Ordering details.

WE 6 61 / E *

3 service ports = 3

4 service ports = 4

Nominal size 6 =6

Symbols see below

Series 60 to 69 = 61

(60 to 69: unchanged installation and connection dimensions)

Spring return = No code

Without spring return = O

Without spring return with detent = OF

High power solenoid = E

Wet pin (oil immersed) with removable coil

12 V DC =G12

220 V AC 50 Hz = W220-50

24 V DC =G24

DC solenoid commuting automatically = W220R

Further details in clear text

No code = mineral oils

V = phosphate ester

No code = Without cartridge throttle

B08 = Throttle Φ 0.8 mm

B10 = Throttle Φ 1.0 mm

B12 = Throttle Φ 1.2 mm

Individual connections:

K4 = with component plug without plug-in connector

Z4 = normal plug

Z5L = Large angled plug with indicator light

Central connections:

DKL = Central connection on cover with indicator light (without angled plug-in connector)

N9 = With protected hand override (standard)

N = With hand override

No code = Without hand override

Symbols

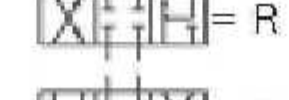
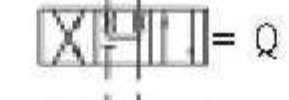
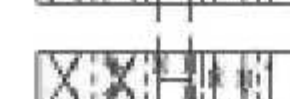
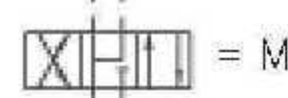
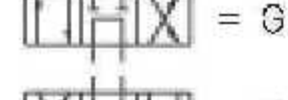
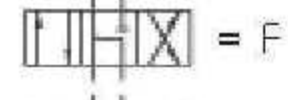
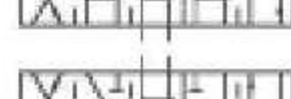
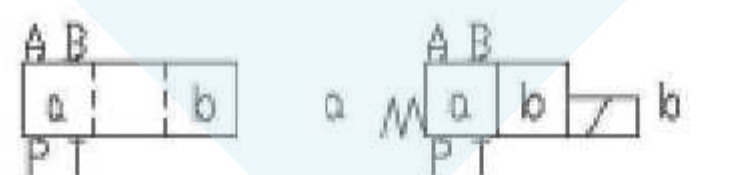
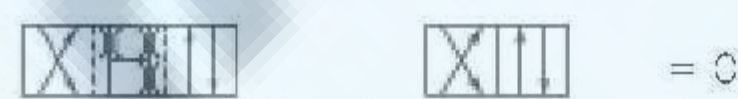
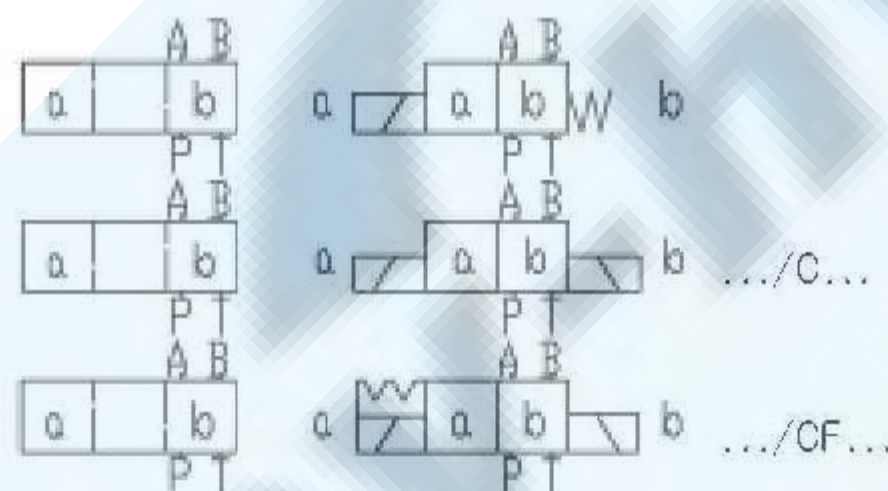

1) Example: Spool E with switching position "a" ordering details..EA "b"

= A 1)

= B

Technical data

Hydraulic			
Max.operating pressure Ports A,B,P	(MPa)	up to 35.0	
Port T	(MPa)	21 (-);16 (~)	
		with symbols A and B, port T must be used as adrain port if the operating pressure is above the permitted tank pressure.	
Max.flow	(L/min)	80 (-);60 (~)	
Pressure fluid		mineral oil, phospate ester	
Viscosity range	(mm ² /s)	2.8 ~ 500	
Pressure fluid temperature range	(°C)	-30 ~ +80	
Degree of contamination		≤ 20(recommendation 10)	
Electrical			
Voltage type		DC	AC 50/60 Hz
Available voltages	(V)	12, 24, 42, 60, 96,	42, 110, 120, 230
		110, 180, 205, 220	50/60Hz
Power consumption	(W)	30	
Holding power	(VA)	-	50
Switch-on power	(VA)	-	220
Duty		continuous	continuous
Switching time to ISO 6403	ON	(ms)	25 to 45
	OFF	(ms)	10 to 25
Protection to DIN		IP 65	
Switching frequency	(cycles/h)	up to 15000	up to 7200
With electrical connections the protective conductor (PE) must be connected according to the relevant regulations.			

Characteristic curves (measured at $\nu = 41 \text{ mm}^2/\text{s}$ and $t = 50^\circ\text{C}$)

7 Symbol "R " in switched position A → B
 8 Symbols "G " and "T " in mid position P → T

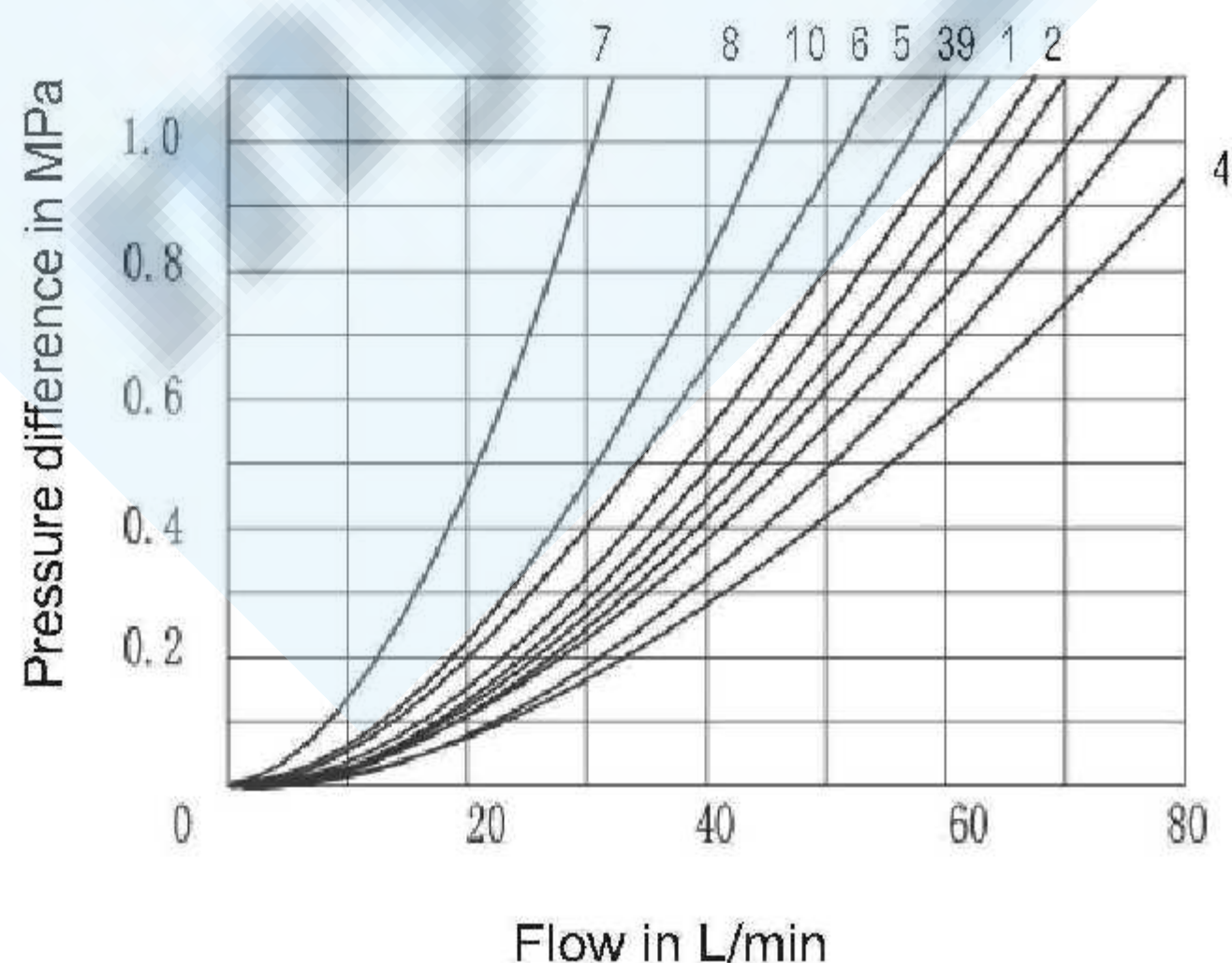

Symbols	Flow direction			
	P → A	P → B	A → T	B → T
A, B	3	3	-	-
C	1	1	3	1
D, Y	5	5	3	3
E	3	3	1	1
F	1	3	1	1
T, G	10	10	9	9
H	2	4	2	2
J, Q	1	1	2	1
L, U	3	3	4	9
M	2	3	3	3
P	3	1	1	1
R	5	5	4	-
V	1	2	1	1
W	1	1	2	2

Performance limits (measured at $v = 41 \text{ mm}^2/\text{s}$ and $t = 50 \text{ }^\circ\text{C}$)

The given switching power limits are for applications with two flow directions (e.g. from P to A and simultaneous return flow from B to T).

Due to the flow forces active within the valves the permissible switching power limit may be significantly less if there is only one direction of flow (e.g. from P to A and port B blocked)!

(Please consult us for applications of this kind.)

The switching power limits were measured with the solenoids at operating temperature, 10% under voltage and without tank back pressure.

DC solenoid G24:24V		AC solenoid - W220:220V,50Hz		AC solenoid - 60Hz W220:220V,60Hz	
Char. curve	Symbol	Char. curve	Symbol	Char. curve	Symbol
1	A, B ¹⁾	11	A, B ¹⁾	19	A, B ¹⁾
2	V	12	V	20	V
3	A, B	13	A, B	21	A, B
4	F, P	14	F, P	22	F, P
5	J	15	G, T	23	G, T
6	G, H, T	16	H	24	J, L, U
7	A/O, A/O ^F , L, U	17	A/O, A/O ^F , C/O, C/O ^F	25	A/O, A/O ^F , Q, W
8	C, D, Y		D/O, D/O ^F , E, E1 ²⁾ , J, L	26	C, D, Y
9	M		M, Q, R ³⁾ , U, W	27	H
10	E, E1 ²⁾ , R ³⁾ , C/O C/O ^F , D/O, D/O ^F , Q, W	18	C, D, Y	28	C/O, C/O ^F , D/O, D/O ^F , E, E1 ²⁾ , M, R ²⁾

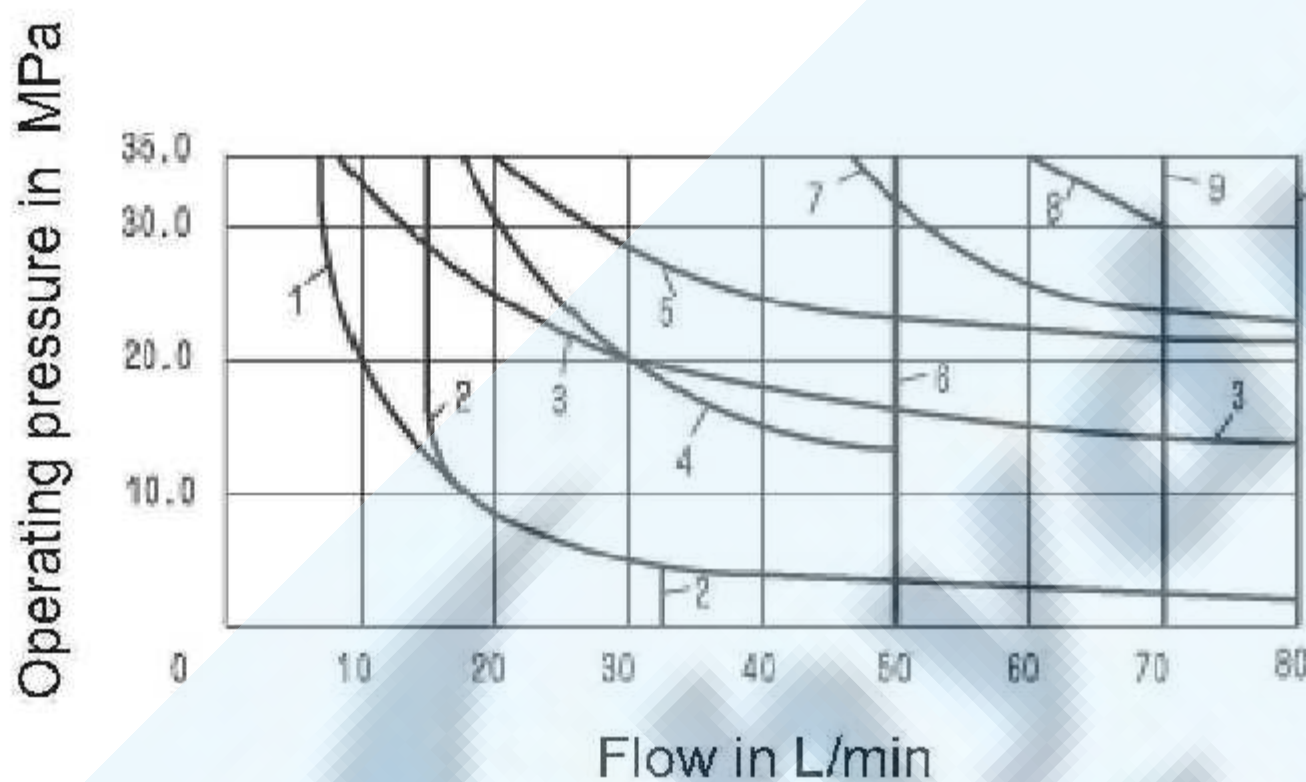

- 1) With hand override
- 2) P → A/B pre-opening
- 3) Return flow from actuator to tank

DC solenoid
Char. curve
1 to 10

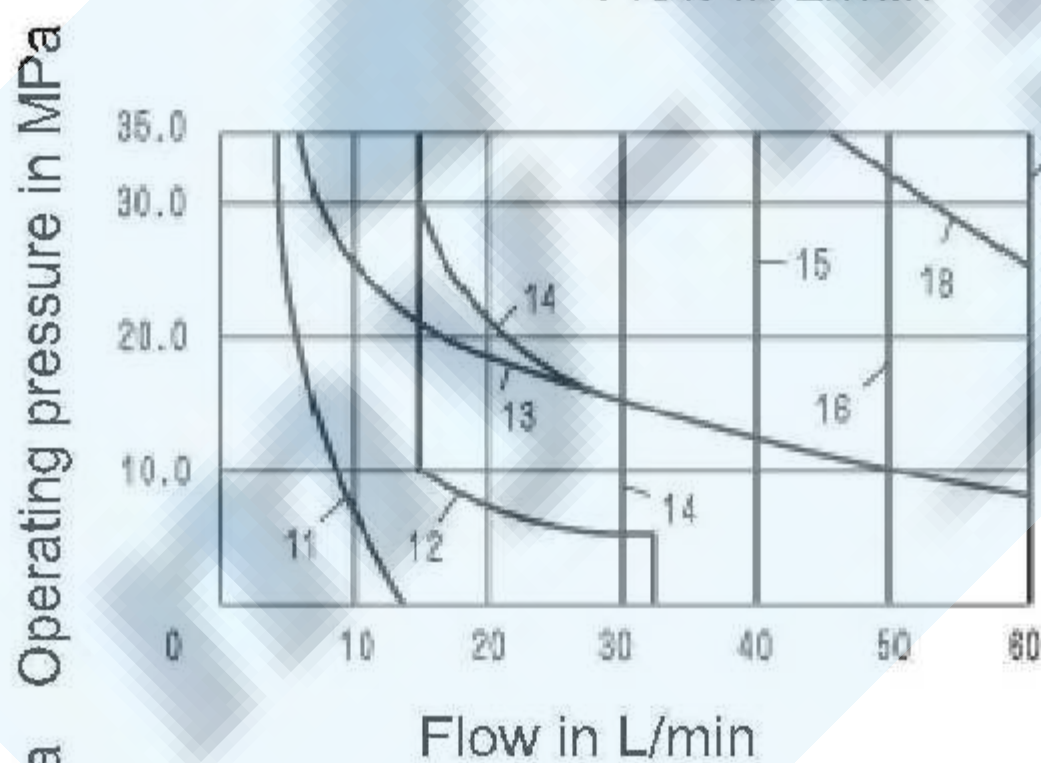

AC solenoid		
Char. curve	Solenoid voltage	
	11 to 18	W42
W110		110V, 50Hz
		120V, 60Hz
W220		220V, 50Hz

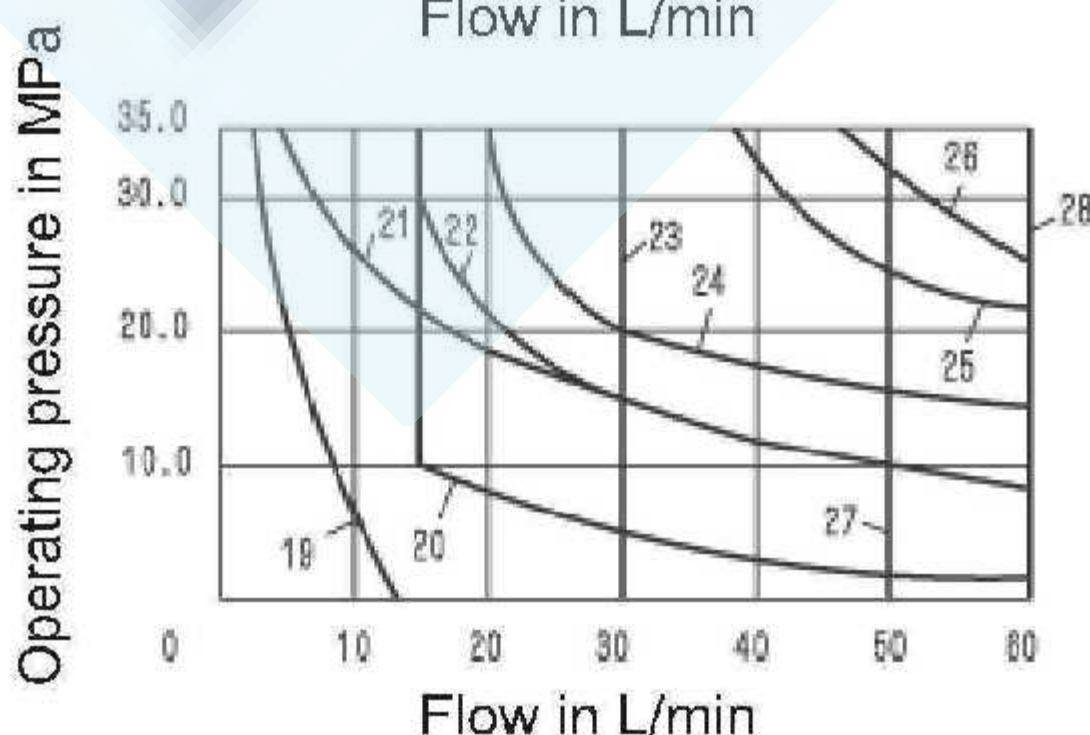

AC solenoid		
Char. curve	Solenoid voltage	
	19 to 20	W42
W110		110V, 60Hz
W220		220V, 60Hz

Unit dimensions: valve with DC solenoid

Individual connections:

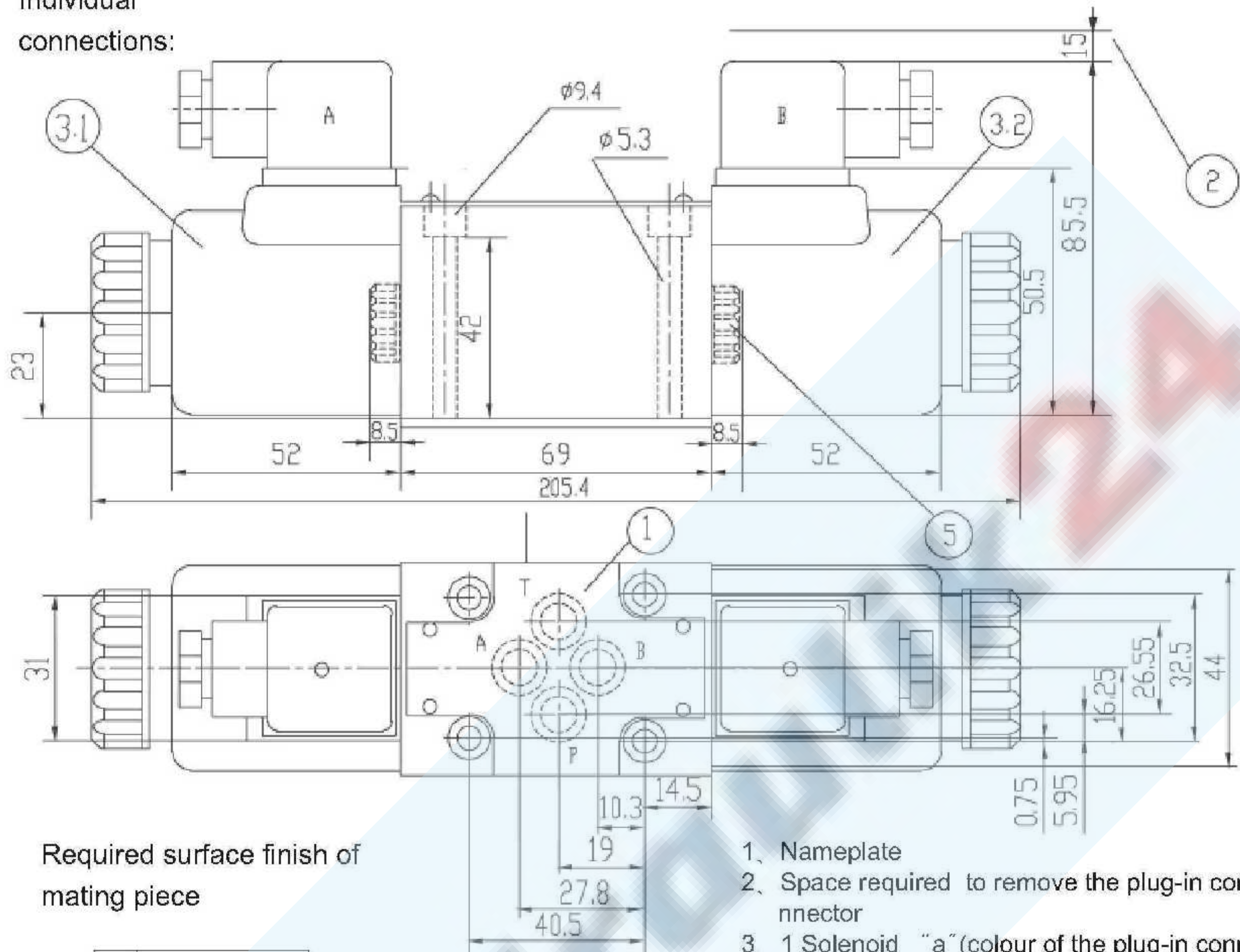

Required surface finish of mating piece

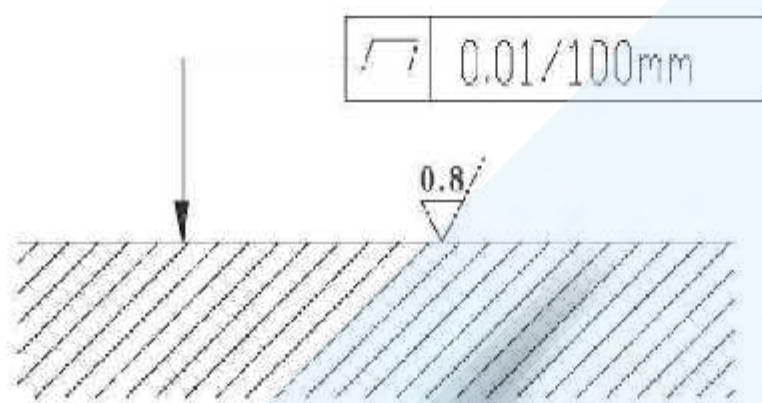

- 1, Nameplate
- 2, Space required to remove the plug-in connector
- 3, 1 Solenoid "a" (colour of the plug-in connector, grey)
- 3, 2 Solenoid "b" (colour of the plug-in connector, black)
- 4, O-ring: 9.25X1.78
- 5, Cover for valve with one solenoid

Central connections:

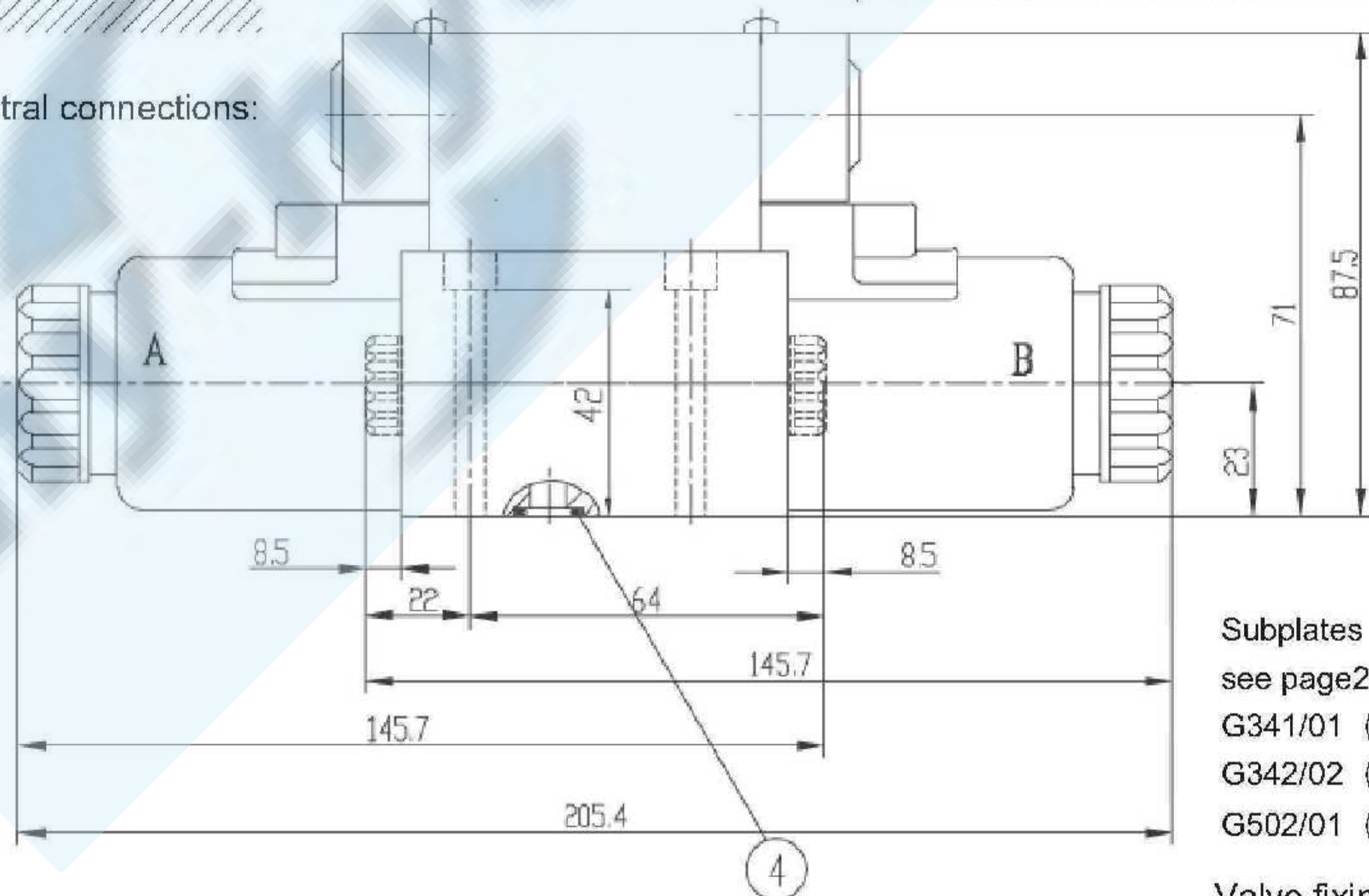

Subplates
see page 205
G341/01 (G1/4");
G342/02 (G3/8");
G502/01 (G1/2");

Valve fixing screws
M5X50 -10.9
(GB/T70.1-2000)
 $M_A=8.9Nm$

Unit dimensions: valve with AC solenoid

Individual connections

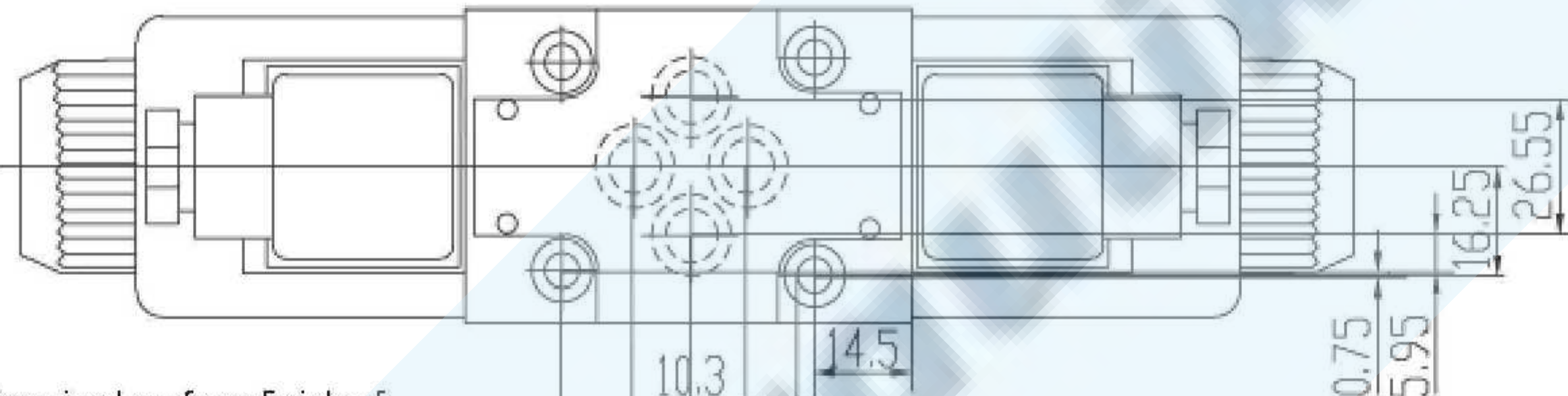
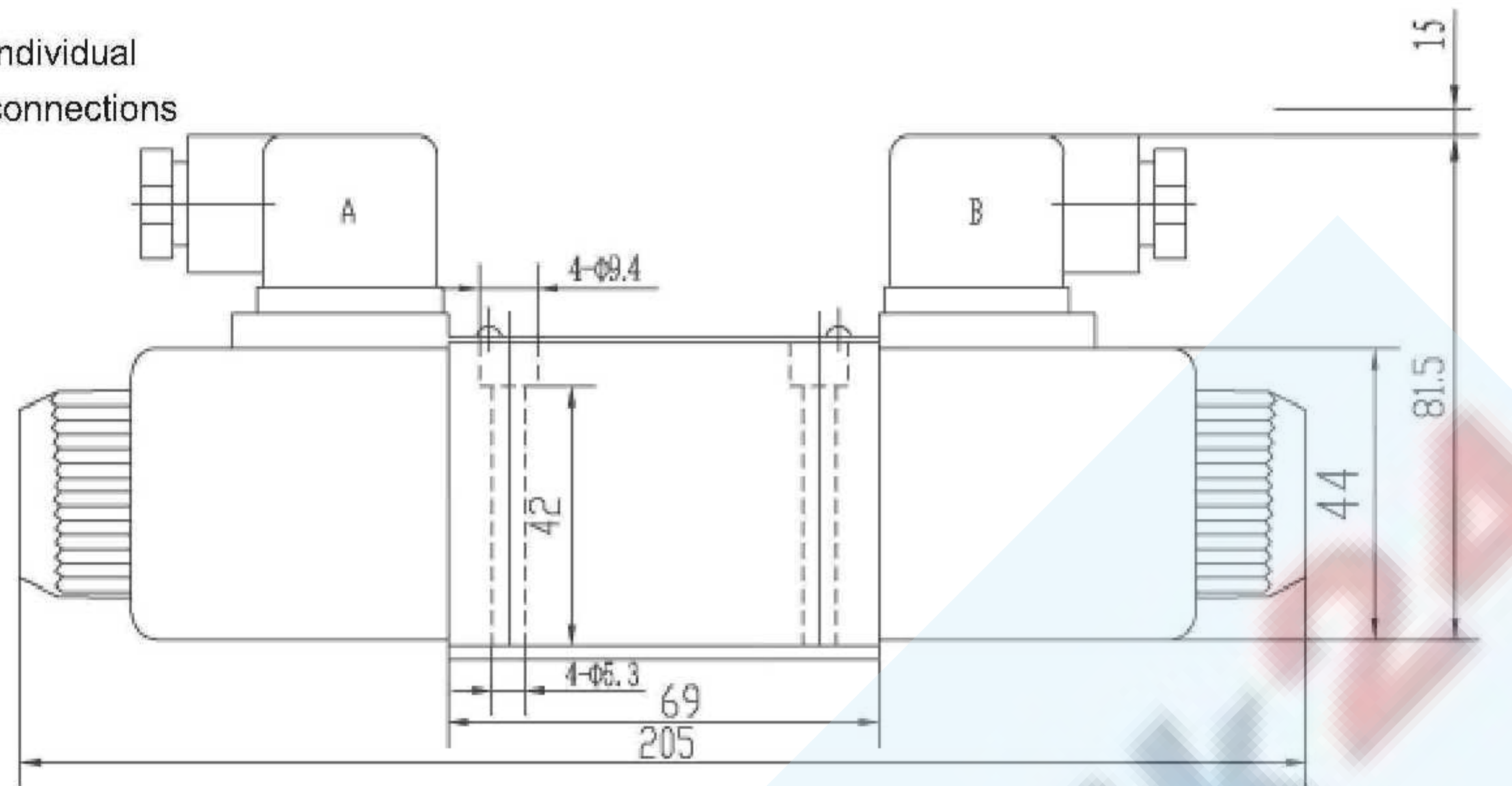

Required surface finish of mating piece

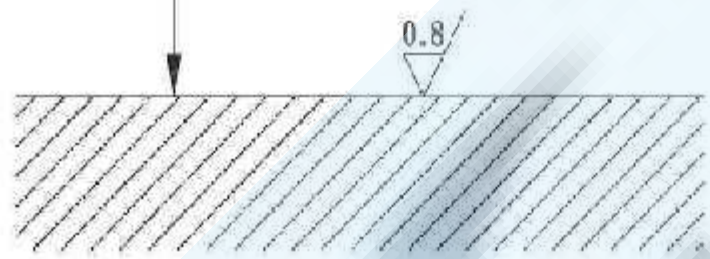

- 1, Nameplate
- 2, Space required to remove the plug-in connector
- 3, 1 Solenoid "a" (colour of the plug-in connector, grey)
- 3, 2 Solenoid "b" (colour of the plug-in connector, black)
- 4, O-ring: 9.25X1.78
- 5, Cover for valve with one solenoid

Central connections:

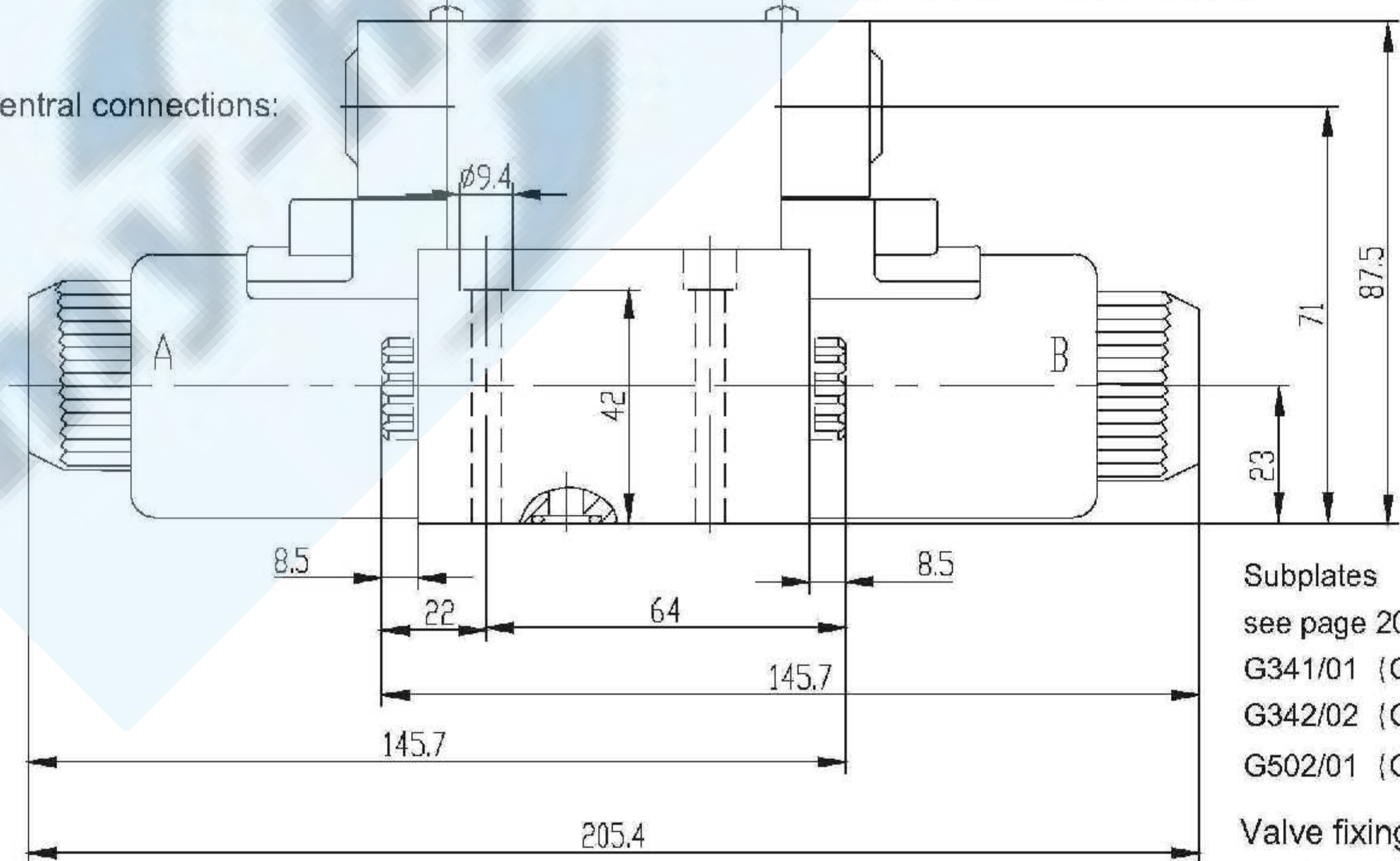

Subplates
see page 205
G341/01 (G1/4");
G342/02 (G3/8");
G502/01 (G1/2");

Valve fixing screws
M5X50 -10.9
(GB/T70.1-2000)
 $M_A=8.9Nm$

Notice

1. The fluid must be filtered. Minimum filter fineness is 20 μm .
2. The tank must be sealing up and an air filter must be installed on air entrance.
3. Products without subplate when leaving factory, if need them, please ordering specially.
4. Valve fixing screws must be high intensity level (class 10.9). Please select and use them according to the parameter listed in the sample book.
5. Roughness of surface linked with the valve is required to $\frac{0.8}{\sqrt{\text{mm}}}$.
6. Surface finish of mating piece is required to 0.01/100mm.